



SCORPION 3™ IX

Fly-First Pitch Type Design

WARNING:

KEEP ALL FLAME AND HEAT SOURCES AWAY FROM THIS TENT FABRIC. THIS TENT MEETS THE FLAMMABILITY REQUIREMENTS OF CPAI-84. THE FABRIC MAY BURN IF LEFT IN CONTINUOUS CONTACT WITH ANY FLAME SOURCE. THE APPLICATION OF ANY FOREIGN SUBSTANCE TO THE TENT FABRIC MAY RENDER THE FLAME-RESISTANT PROPERTIES INEFFECTIVE.





WARNING: KEEP ALL FLAME AND HEAT SOURCES AWAY FROM THIS TENT.

This tent is not fireproof. The fabric will burn if left in continuous contact with a flame source.

MISE EN GARDE: TENIR CETTE TENTE LOIN DE TOUTE FLAMME ET DE TOUTE SOURCE DE CHALEUR.

Cette tente n'est pas ininflammable. Le tissu brûlera s'il est laissé en contact continu avec une source de flamme.

Assembly Instructions for SCORPION 3™ IX

-  X2 GreenTip (Angled)
-  X1 GreyTip (Straight)
-  X20 Alloy Stakes

Pole Placement

1. Insert one Green Tip Angled Pole with Green section to Green trim edging.
2. Insert the other Green Tip Angled Pole with Green section to Green trim edging.
3. Insert the Grey Tip Straight Pole with Grey section to Grey trim edging.

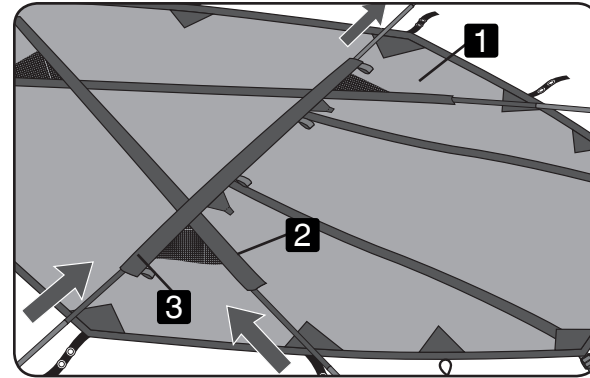

Additional Ultralight Alloy Original Stakes can be purchased separately. Aftermarket stakes can also be used with this tent whether it be with the loop webbing or through the secondary grommet available.

1

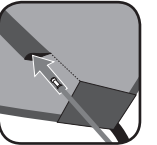
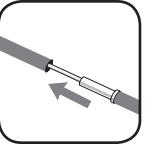
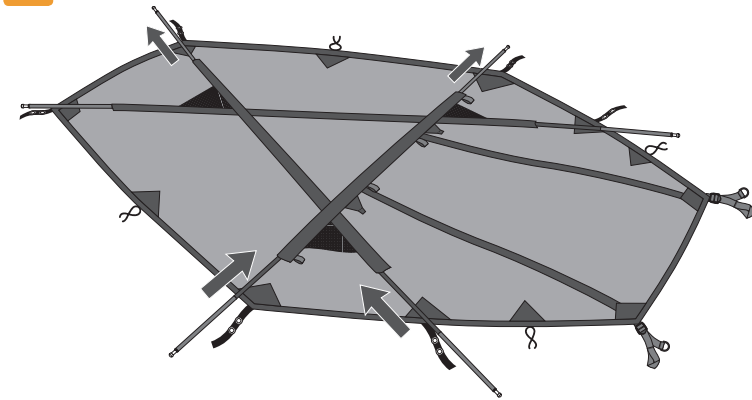

- a. Take out the Fly (Outer Tent) and unfold and spread it out.
- b. Assemble Pole Sections - Carefully unfold the pole sections and allow them to slide together by inserting within one another.
- c. Insert the poles into the pole sleeve channels (we recommend to always push poles through, do not pull through sleeve channels).

2

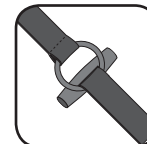
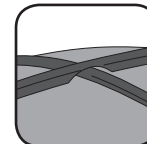
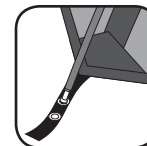

- a. Insert the tent pole ends into the grommets in the corresponding webbing straps. Once all the pole ends are inserted into the grommets the fly should now stand erected.
- b. The pole channels and poles should intersect for proper form, support and structure.
- c. Now unzip the door and open it to gain access to the inside of the Fly (Outer Tent).
- d. Take the Inner Tent and line up the Door and vents and start to attach the toggle to the corresponding supporting ring on the Fly (recommend one start from the back and work their way out from the main door and vestibule).

3



- a. Once the Inner Tent is connected with the Fly by all the Toggle and Ring attachments, then click all the side release buckles together.
- b. Then take the Ultralight Alloy Stakes that came with the tent and run them through the loop of the webbing with the grommets and stake down accordingly.
- c. Once the tent is Staked out / down then adjust the tension of the Side Release buckles webbing of the Inner tent to achieve the desired result (Note: there is a secondary grommet visible on webbing strap for different stakes if needed).